

# Professional Pavillons



# Pavillons Carrousel A

Color

RAL  
9005

RAL  
6009

Security 4mm

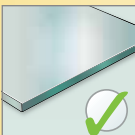

Polycarbon 10mm

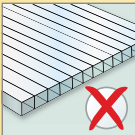
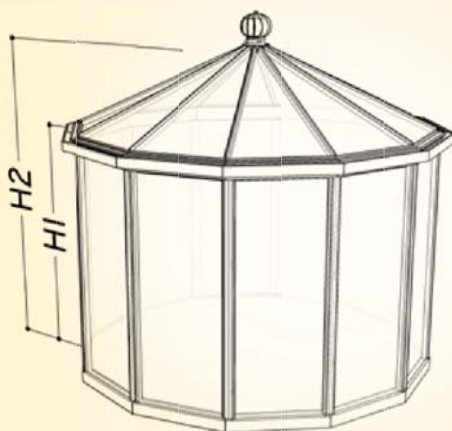
**DIY** Mounting difficulty

EASY 1 2 3 COMPLEX

Type	Diameter (cm)	M <sup>2</sup>	H1 (cm)	H2 (cm)				
CARA310	310 cm	7,5m <sup>2</sup>	204 cm	277/307 cm	25 °	-	-	-
CARA378	378 cm	11,2m <sup>2</sup>	204 cm	281/311 cm	25 °	-	-	-
CARE	73 cm	2,3m <sup>2</sup>	-	-	-	-	-	-

# Pavillons Carrousel B

Color

RAL  
9005

RAL  
6009

Security 4mm

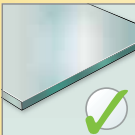

Polycarbon 10mm

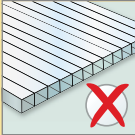
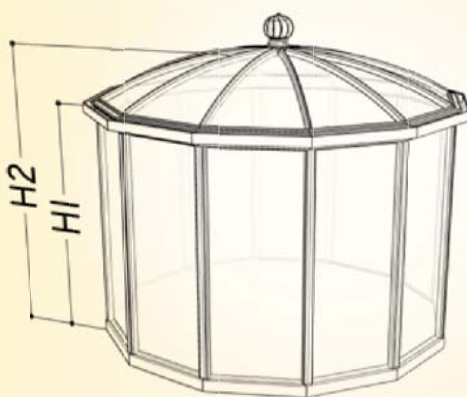
**DIY** Mounting difficulty

EASY 1 2 3 COMPLEX

Type	Diameter (cm)	M <sup>2</sup>	H1 (cm)	H2 (cm)				
CARB310	310 cm	7,5m <sup>2</sup>	204 cm	247/277 cm	25 °	-	-	-
CARB378	378 cm	11,2m <sup>2</sup>	204 cm	270/300 cm	25 °	-	-	-
CARE	73 cm	2,3m <sup>2</sup>	-	-	-	-	-	-

✓ Included   
 ✓ Optional   
 ✗ Not available

## Carrousel Garden Pavillions

### The Basic Price of a Carrousel includes:

- Aluminium frame manufactured from very strong 'box section' profiles
- Polyester Powder coated frame in Green or Black
- 4mm clear Toughened Glass
- Full length rubber glazing strips to securely fasten the glass
- Heavy Duty Hinged door (or doors) with door lock
- Top Hinged Side windows
- Aspiromatic Roof Ventilator (on round models only)
- Stainless Steel Nuts and Bolts
- Full length aluminium rainwater downpipes
- Instruction manual and assembly DVD
- Delivery in kit form (by truck) for self assembly
- 13 Year warranty on the frame (against defects in manufacture)

### Carrousel Type A (Green or Black frame) and 4mm Toughened Glass side and roof panes

Size (width and length)	Top Hinged	Aspiromatic	Hinged Door	
	Side Windows	Roof Ventilator		
310cm x 310cm (10ft 2ins x 10ft)	2	1	Single	€6,686
310cm x 458cm (10ft 2ins x 15ft)	3	0	Single	€9,489
310cm x 606cm (10ft 2ins x 19ft 11ins)	4	0	Single	€12,292
378cm x 378cm (12ft 6ins x 12ft 6ins)	2	1	Double	€7,735
378cm x 526cm (12ft 6ins x 17ft 3ins)	3	0	Double	€10,538
378cm x 674cm (12ft 6ins x 22ft 1in)	4	0	Double	€13,341

### Carrousel Type B (Green or Black frame) and 4mm Tough Glass sides and a Plexi Glass Curved Roof

Size (width and length)	Top Hinged	Aspiromatic	Hinged Door	
	Side Windows	Roof Ventilator		
310cm x 310cm (10ft 2ins x 10ft)	2	1	Single	€7,583
310cm x 458cm (10ft 2ins x 15ft)	3	0	Single	€10,386
310cm x 606cm (10ft 2ins x 19ft 11ins)	4	0	Single	€13,189
378cm x 378cm (12ft 5ins x 12ft 6ins)	2	1	Double	€9,048
378cm x 526cm (12ft 5ins x 17ft 3ins)	3	0	Double	€11,851
378cm x 674cm (12ft 5ins x 22ft 1in)	4	0	Double	€14,654

### Professional Construction service available countrywide.

The average cost for building this model is about 20% of the value of the Pavillion with accessories and assumes you will have a flat and level site prepared in advance for it. Please contact us if you would like an accurate quotation.

**Frame Powder Coating Colour Options**

Dark Grey RAL7016, Light Grey RAL9006, White RAL9010	€775
Red Brown RAL3011, Blue RAL5011:	€775
Any other RAL colour:	€1,240

**Rubber Glazing Strip Colour**

Black Rubber Glazing Strip supplied as standard. White or Green Rubber Glazing Strip available on request for Green or White powder coated frames (without extra cost)

**Doors**

Extended length of a single door to have a zero door threshold	€155
Extended length of double doors to have a zero door threshold	€310

**Decorative Aluminium Lower Panels**

Greenhouse Size (width and length)	
310cm x 310cm (10ft 2ins x 10ft)	€1,674
310cm x 458cm (10ft 2ins x 15ft)	€2,418
310cm x 606cm (10ft 2ins x 19ft 11ins)	€3,162
378cm x 378cm (12ft 5ins x 12ft 6ins)	€1,488
378cm x 526cm (12ft 5ins x 17ft 3ins)	€2,232
378cm x 674cm (12ft 5ins x 22ft 1in)	€2,976

**Ventilation**

Top Hinged Side Window	€353
Louvre Vent (in black only)	€93
Automatic Louvre Vent Opener	€35

**Reinforcement for very exposed ares**

Supplementary Glazing Pack for very exposed sites	€102
---	------

**Other Accessories**

We also supply heaters, propagation equipment, irrigation and much more, please ask for our Glasshouse Accessories Catalogue to see the full range of Greenhouse accessories which we supply.

Prices include VAT.

# Options & Accesories



RAL I: 7016 - 9010- 3011  
5011- 9006  
RAL II: all other colors

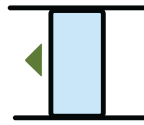

SD

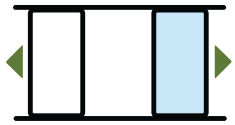

SD2



FREEZE

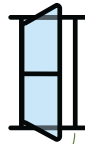

HD

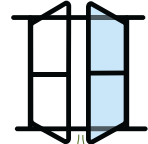

HD2

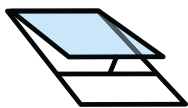

RW



TW

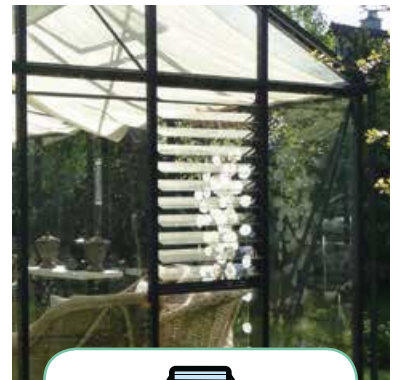

LV



DECOR1

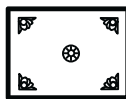

DECOR2

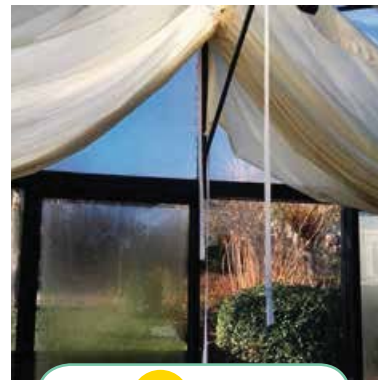

SUN  
L = 300 cm

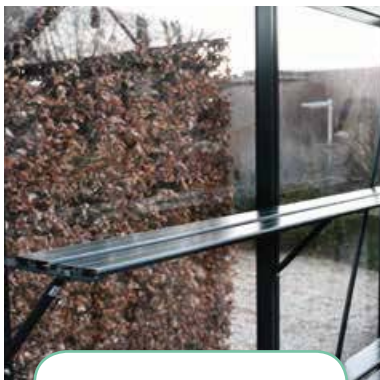

TAB2  
L = 150 cm

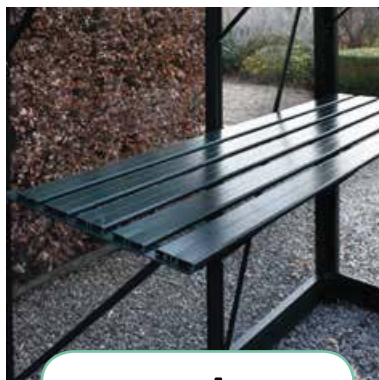

TAB5  
L = 150 cm



ST  
L = 236 cm / 310 cm  
458 cm / 606 cm

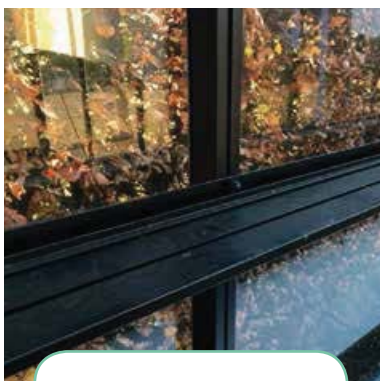

SH  
L = 236 cm / 310 cm  
458 cm / 606 cm



AP

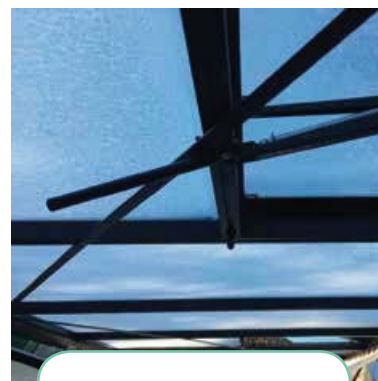

RW AUT  
LV AUT